



## 1 ESTRUCTURA POLIVALENTE STRUKT DE 40X40

### Montante 40x40, recto

Anodizado seda	151.100.515	 1
----------------	-------------	---

Cortado a medida.

### Montante o travesaño 40x40, un corte a 45°

Anodizado seda	151.145.514	 1
----------------	-------------	---

Cortado a medida.

### Montante o travesaño 40x40, dos cortes a 45°

Anodizado seda	151.245.511	 1
----------------	-------------	---

Cortado a medida.

### Unión angular

Natural	519.500.100	 1
---------	-------------	---

### Unión mensula

	40mm.	110mm.	
Anodizado seda	519.904.512		1
Anodizado seda		519.911.512	

La de 40mm. se suministra en cajas de 20 uds., para 5 baldas. La de 110mm. en cajas de 10 Uds., para 5 baldas. Cada referencia incluye la tuerca de unión.

### Pata regulable

Anodizado seda	164.000.513	 1
----------------	-------------	---

### Terminal a pared, techo o soporte para encimera

Anodizado seda	164.100.510	 1
----------------	-------------	---

Sirve tanto para unir la estructura a la pared o techo como para unir elementos horizontales (encimeras, mesas...) a la misma.

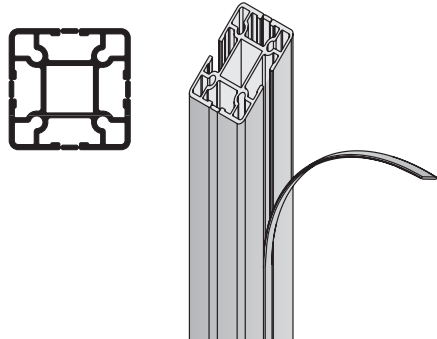

Para liberar el canal basta con arrancar la tira de aluminio que lo protege

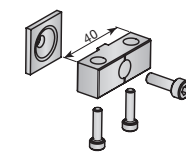
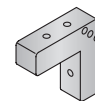

Unión de 40mm. para soportar las baldas en esquina

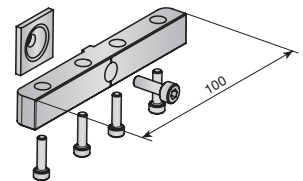

Unión de 110mm. para soportar las baldas por el centro

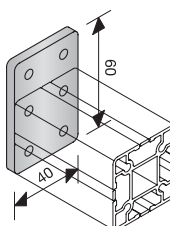
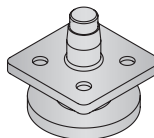

**Tuerca para otros elementos**

Natural	164.200.105	1	
---------	-------------	---	---

Permite la incorporación de otros elementos como módulos de cajones, laterales en madera para bisagras o cajoneras o laterales y traseras en madera para formar un armario.

**Balda para cristal o panel de 10mm.**

Tipo de montaje	En la esquina	En el centro	
Normal	171.501.514	171.601.511	1
Con soportes y barra de colgar	171.502.516	171.602.513	

Anodizado seda. Cortado y mecanizado a medida. Se incluyen las escuadras de unión y los junquillos para el cristal.

